

B-60 - Kolano



B-60 - Kolano okrągłe 60° chemoodporne wykonane z tworzyw sztucznych

Wykonanie:

- kolano kąt <math><60^\circ</math>
- promień $R = D$
- formowane maszynowo do 315mm
- formowane ręcznie od 355mm do 800mm
- wykonanie segmentowe powyżej 800mm
- minimalna grubość ścianki 3 mm lub zgodnie z DIN 4741
- zakończenia mufowe (M)
- łączenie przez klejenie/spawanie/skręcanie



Dane techniczne

Temperatura stosowania:

Tr [°C] jak dla materiału

Temperatura pracy:

Tmax. [°C] jak dla materiału

Ciśnienie pracy:

Pmax. [Pa] jak dla materiału

Kolor:

jak dla materiału

Wymiarowanie:

Kolano B [m] - 60 - [d]





[m] - typ materiału

[d] - średnica kanału wentylacyjnego w mm

Uwagi:

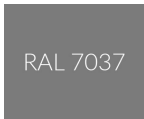
Kolana dostępne także w wersji 15°, 30°, 45°, 75° i 90°.

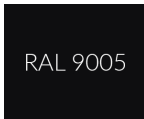
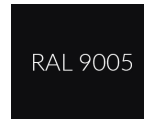
Oznaczenie:

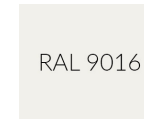
Typ	B1-60	B2-60	B3-60	B4-60	B5-60	B6-60	B9-60
Materiał	PVC-U	PPs	PP	PE	PPs-el	PVDF	PVC-UV
Kolor							
Nazwa	polichlorek winyłu	polipropylen samogasnący	polipropylen	polietylen	polipropylen samogasnący elektroprzewodzący	polifluorek winylidenu	polichlorek winyłu

Wymiary

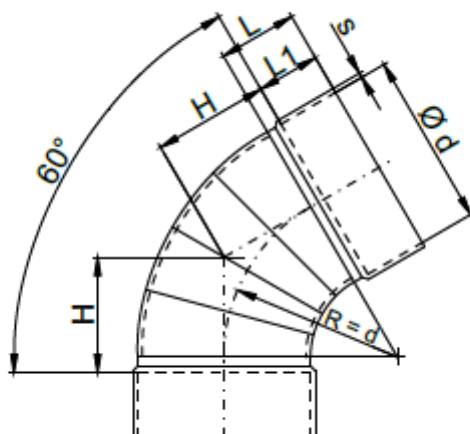

d [mm]	PVC / PVC-UV					PP / PPs / PE / PPs-el / PVDF				
	L [mm]	L1 [mm]	H [mm]	s [mm]	m [kg]	L [mm]	L1 [mm]	H [mm]	s [mm]	m [kg]
0050	30	25	40	3,0	0,1	30	25	35	3,0	0,1
0063	30	25	45	3,0	0,1	30	25	40	3,0	0,1
0075	40	35	50	3,0	0,1	40	35	50	3,0	0,1
0090	40	35	55	3,0	0,1	40	35	55	3,0	0,2
0110	50	40	75	3,0	0,2	50	40	75	3,0	0,2
0125	50	40	80	3,0	0,3	50	40	80	3,0	0,3
0140	50	40	90	3,0	0,3	50	40	90	3,0	0,4
0160	50	40	100	3,0	0,4	50	40	100	3,0	0,4
0180	60	50	115	3,0	0,5	60	50	115	3,0	0,5
0200	60	50	125	3,0	0,7	60	50	125	3,0	0,7
0225	60	50	140	3,5	0,8	60	50	140	3,5	0,9
0250	60	50	155	3,5	1,1	60	50	155	4,0	1,0
0280	60	50	170	3,5	1,3	60	50	170	4,0	1,5
0315	60	50	190	3,5	1,9	60	50	190	5,0	2,3
0355	60	50	215	3,5	2,3	60	50	215	5,0	2,8
0400	70	60	240	3,5	2,9	70	60	245	6,0	4,3

d [mm]	PVC / PVC-UV					PP / PPs / PE / PPs-el / PVDF				
0450	70	60	280	3,5	4,7	70	60	275	6,0	6,1
0500	70	60	300	4,0	6,7	70	60	310	6,0	6,8
0560	-	-	-	-	-	110	90	345	6,0	8,7
0600	80	70	360	5,0	9,8	-	-	-	-	-
0630	-	-	-	-	-	115	90	385	8,0	9,2
0700	110	90	430	6,0	18,5	-	-	-	-	-
0710	-	-	-	-	-	115	90	430	8,0	14,2
0800	115	100	480	7,0	22,9	115	100	480	10,0	28,3
0900	115	100	605	8,0	41,3	115	100	605	8,0	33,7
1000	115	100	605	8,0	57,3	115	100	605	8,0	50,9