

B-75 - Kolano



B-75 - Kolano okrągłe 75° chemoodporne wykonane z tworzyw sztucznych

Wykonanie:

- kolano kąt <75°
- promień $R = D$
- formowane maszynowo do 315mm
- formowane ręcznie od 355mm do 800mm
- wykonanie segmentowe powyżej 800mm
- minimalna grubość ścianki 3 mm lub zgodnie z DIN 4741
- zakończenia mufowe (M)
- łączenie przez klejenie/spawanie/skręcanie



Dane techniczne

Temperatura stosowania:

Tr [°C] jak dla materiału

Temperatura pracy:

Tmax. [°C] jak dla materiału

Ciśnienie pracy:

Pmax. [Pa] jak dla materiału

Kolor:

jak dla materiału

Wymiarowanie:

Kolano B [m] - 75 - [d]





[m] - typ materiału

[d] - średnica kanału wentylacyjnego w mm

Uwagi:

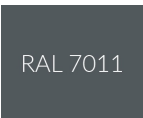
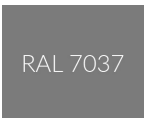
Kolana dostępne także w wersji 15°, 30°, 45°, 60°, 90°.

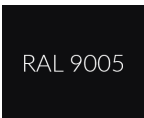
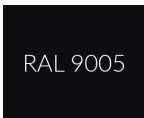
Oznaczenie:

Typ	B1-75	B2-75	B3-75	B4-75	B5-75	B6-75	B9-75
Materiał	PVC-U	PPs	PP	PE	PPs-el	PVDF	PVC-UV
Kolor	 RAL 7011	 RAL 7037	 RAL 7032	 RAL 9005	 RAL 9005	 NATURAL	 RAL 9016
Nazwa	polichlorek winyłu	polipropylen samogasnący	polipropylen	polietylen	polipropylen samogasnący elektroprzewodzący	polifluorek winylidenu	polichlorek winyłu

Wymiary

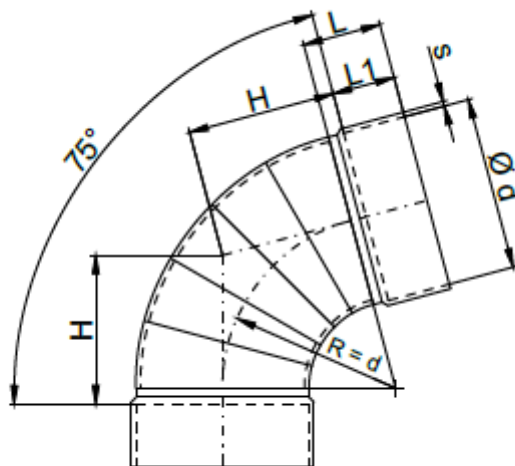

d [mm]	PVC / PVC-UV					PP / PPs / PE / PPs-el / PVDF				
	L [mm]	L1 [mm]	H [mm]	s [mm]	m [kg]	L [mm]	L1 [mm]	H [mm]	s [mm]	m [kg]
0050	30	25	50	3,0	0,1	30	25	45	3,0	0,1
0063	30	25	60	3,0	0,1	30	25	55	3,0	0,1
0075	40	35	65	3,0	0,1	40	35	65	3,0	0,1
0090	40	35	75	3,0	0,1	40	35	75	3,0	0,2
0110	50	40	95	3,0	0,2	50	40	95	3,0	0,3
0125	50	40	105	3,0	0,4	50	40	105	3,0	0,3
0140	50	40	115	3,0	0,4	50	40	115	3,0	0,4
0160	50	40	135	3,0	0,5	50	40	135	3,0	0,5
0180	60	50	150	3,0	0,6	60	50	150	3,0	0,6
0200	60	50	165	3,0	0,8	60	50	165	3,0	0,8
0225	60	50	185	3,5	1,0	60	50	185	3,5	1,0
0250	60	50	200	3,5	1,4	60	50	200	4,0	1,3
0280	60	50	225	3,5	1,6	60	50	225	4,0	1,8
0315	60	50	250	3,5	2,4	60	50	250	5,0	2,7
0355	60	50	280	3,5	2,8	60	50	280	5,0	3,3
0400	70	60	315	3,5	3,7	70	60	320	6,0	5,0

d [mm]	PVC / PVC-UV					PP / PPs / PE / PPs-el / PVDF				
0450	70	60	365	3,5	5,8	70	60	360	6,0	5,7
0500	70	60	405	4,0	8,0	70	60	405	6,0	7,5
0560	-	-	-	-	-	110	90	450	6,0	9,1
0600	80	70	470	5,0	12,0	80	70	470	8,0	-
0630	-	-	-	-	-	110	90	485	8,0	11,6
0700	110	90	565	6,0	22,0	110	90	565	8,0	-
0710	-	-	-	-	-	110	90	565	8,0	19,0
0800	120	100	630	7,0	28,0	120	100	630	10,0	33,0
0900	130	110	795	8,0	50,3	130	110	795	8,0	43,2
1000	130	110	795	8,0	66,8	130	110	795	8,0	58,5